



LOCATOR R-Tx™
REMOVABLE ATTACHMENT SYSTEM

LOCATOR R-Tx™

TECHNIQUE MANUAL

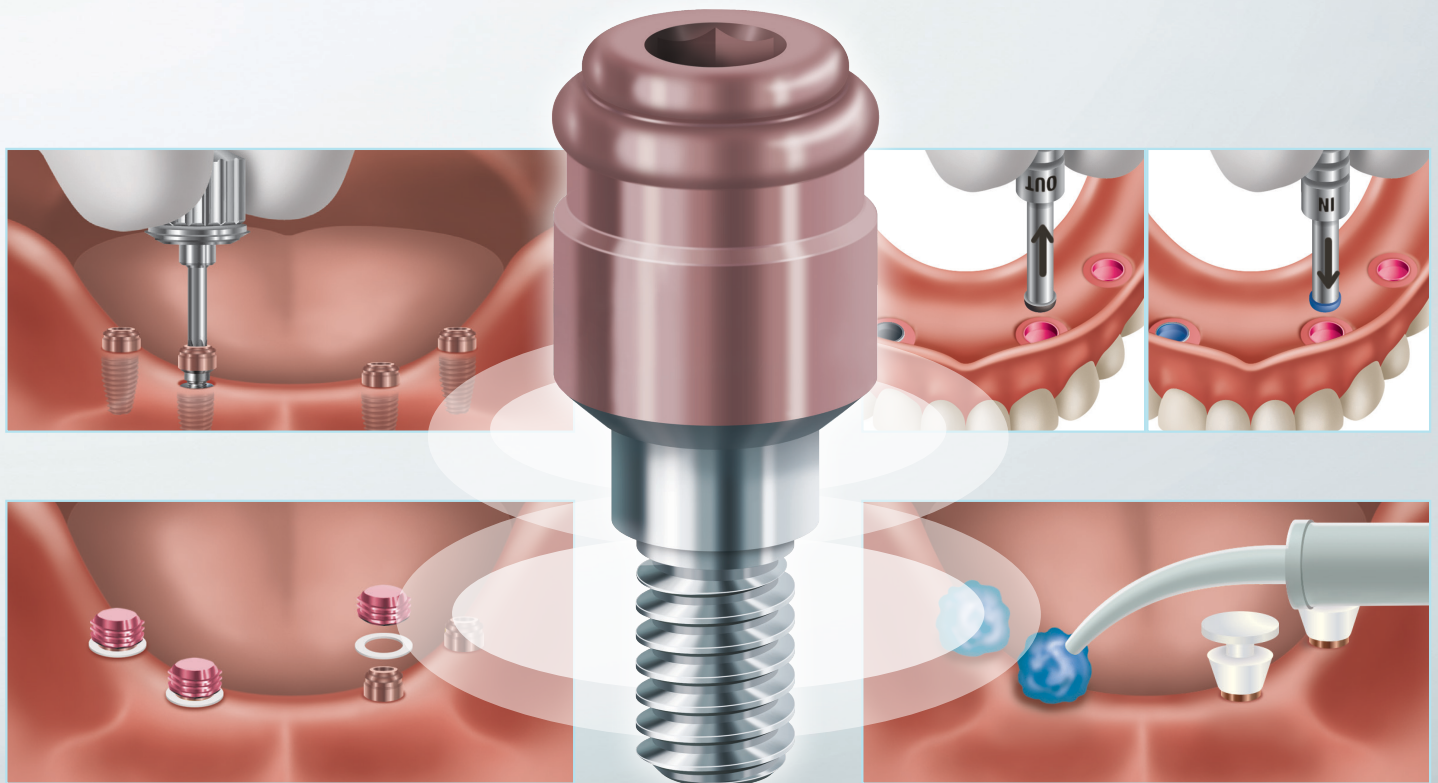

TABLE OF CONTENTS

LOCATOR R-Tx™ Removable Attachment System Technique Manual

| | |
|----|--|
| 1 | TABLE OF CONTENTS |
| 2 | LOCATOR R-Tx COMPONENTS REFERENCE |
| 3 | LOCATOR R-TX |
| 3 | The Next Generation of the World's Leading Overdenture Attachment System |
| 4 | Overview of System Features |
| 7 | ABUTMENT PLACEMENT |
| 8 | PROCESSING DENTURE ATTACHMENT HOUSINGS INTO THE DENTURE |
| 8 | Direct Technique |
| 11 | Indirect Technique |
| 15 | MAINTENANCE OF THE LOCATOR R-Tx ABUTMENT |
| 15 | Reline of Implant-Retained Tissue Supported Overdentures |
| 18 | IMPORTANT INFORMATION ABOUT THE LOCATOR R-Tx REMOVABLE ATTACHMENT SYSTEM |
| 18 | Indications |
| 18 | Contraindications |
| 18 | Caution |
| 18 | Single-Use Devices |
| 18 | Retention Insert Tool |
| 18 | Cleaning |
| 18 | Sterilization |
| 19 | OVERDENTURE INSERTION, REMOVAL, AND CLEANING GUIDELINES |
| 19 | Inserting and Removing an Overdenture |
| 19 | Cleaning an Overdenture |
| 19 | Additional Notes of Caution |
| 20 | RETURN POLICY AND WARRANTY |

IMPORTANT: This document is designed to serve as a reference guide for dental clinicians using ZEST Anchors products. It is not intended to be a substitute for professional training and experience. Please refer to the instructions for use for further information.

LOCATOR R-Tx™ COMPONENTS REFERENCE

LOCATOR R-Tx ABUTMENTS



LAB PROCESSING

Impression Coping
30017
(QTY. 4)



3.35mm Abutment
Analog
30014
(QTY. 4)

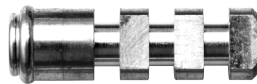

4.0mm Abutment
Analog
30015
(QTY. 4)

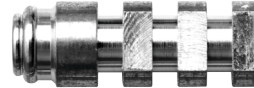

5.0mm Abutment
Analog
30016
(QTY. 4)

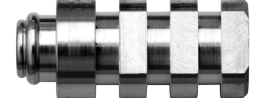

Processing Spacer
30018
(QTY. 4)



Denture Attachment
Processing Assembly
30013
(QTY. 4)



Block-out Spacer
08514
(QTY. 20)



RETENTION INSERTS

Zero
Retention Insert
30001
(QTY. 4)



Low
Retention Insert
30002
(QTY. 4)



Medium
Retention Insert
30003
(QTY. 4)



High
Retention Insert
30004
(QTY. 4)



Extra High
Retention Insert
30005
(QTY. 4)



TOOLS

Retention Insert Tool
30021



LOCATOR R-Tx™

The Next Generation of the World's Leading Overdenture Attachment System

Unveiling LOCATOR R-TX, a better, simpler, and stronger system that relies on the same restorative techniques as the award-winning LOCATOR®.

At ZEST Anchors, we proudly claim a 40-year heritage of overdenture attachment innovation.

Over the past decade and a half, the LOCATOR Attachment System has grown dramatically, evolving into the undisputed market leader for implant-retained, tissue-supported overdenture attachments. Trusted by the industry, the clinician community, and patients alike.

In keeping with our innovative spirit, ZEST has continued to refine and even reimagine LOCATOR.

We started by listening to you, the influential specialists, clinicians, and manufacturers. Then, our engineers put those ideas to the test and into real application.

Welcome to LOCATOR R-Tx.

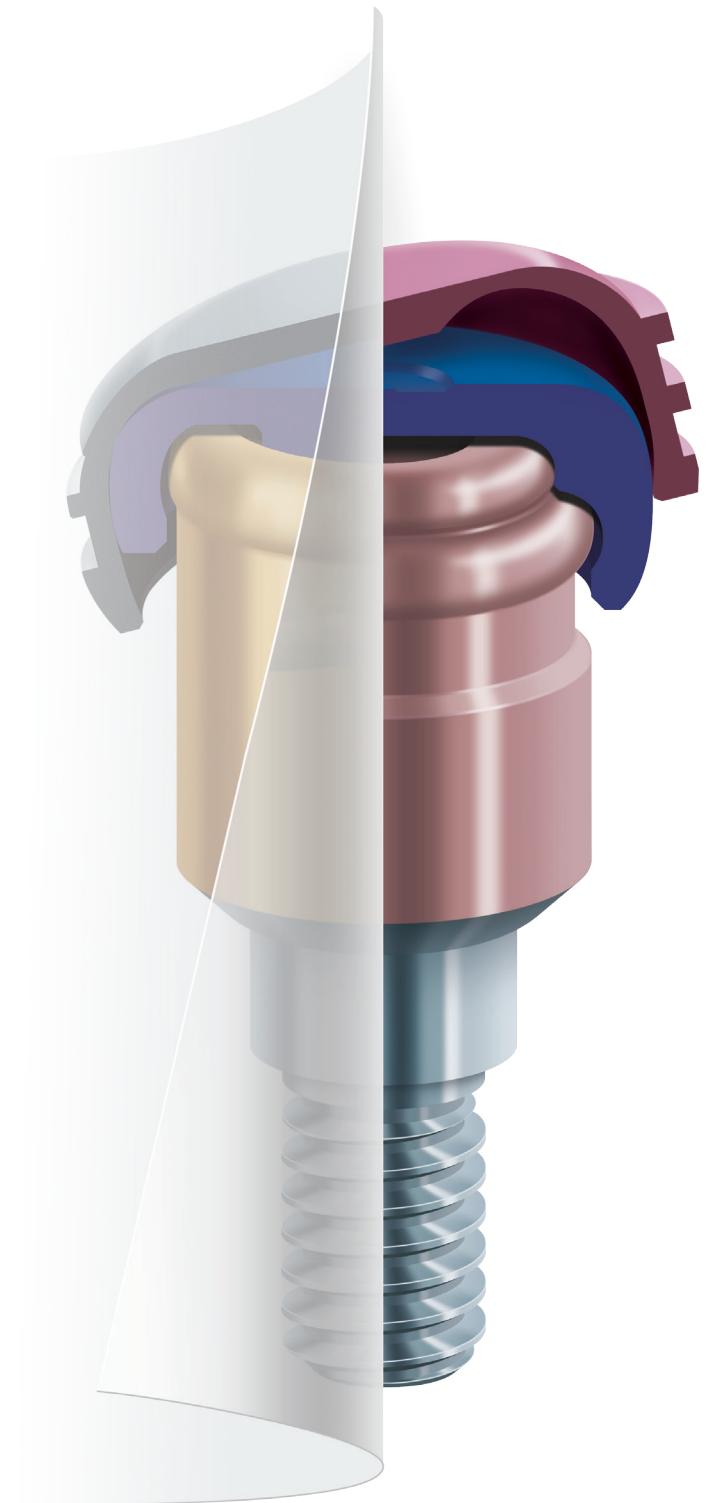

LOCATOR R-Tx™

Overview of System Features

ABUTMENT

1 Dual retentive surfaces for engagement and narrower coronal geometry for easier seating of overdenture.



2 Industry standard .050"/1.25mm* hex drive mechanism.

3 DuraTec™ Titanium Carbon Nitride Coating is aesthetic, harder and more wear resistant.

DENTURE ATTACHMENT HOUSING/ RETENTION INSERT

1 50% increase in pivoting capability to 60 degrees between implants.

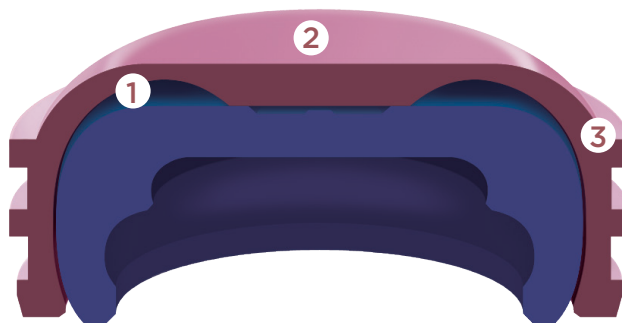

2 Pink Anodization for Improved Aesthetics

3 Flats & grooves for enhanced fixation

1 EASIER DENTURE SEATING WITH PIVOTING TECHNOLOGY

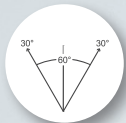

The magic of LOCATOR® has been that the Nylon Retention Insert pivots within the Denture Attachment Housing during insertion/removal, resulting in a resilient system that has allowed patients to seat their overdenture without damaging the components, even in the presence of divergence or convergence between implants.

Patented modifications to the Denture Attachment Housing now allow the Housing to pivot up to 30° over the seated LOCATOR R-Tx Nylon Retention Inserts to treat a maximum of 60° convergence/divergence between implants, eliminating the need for pre-angled abutments.

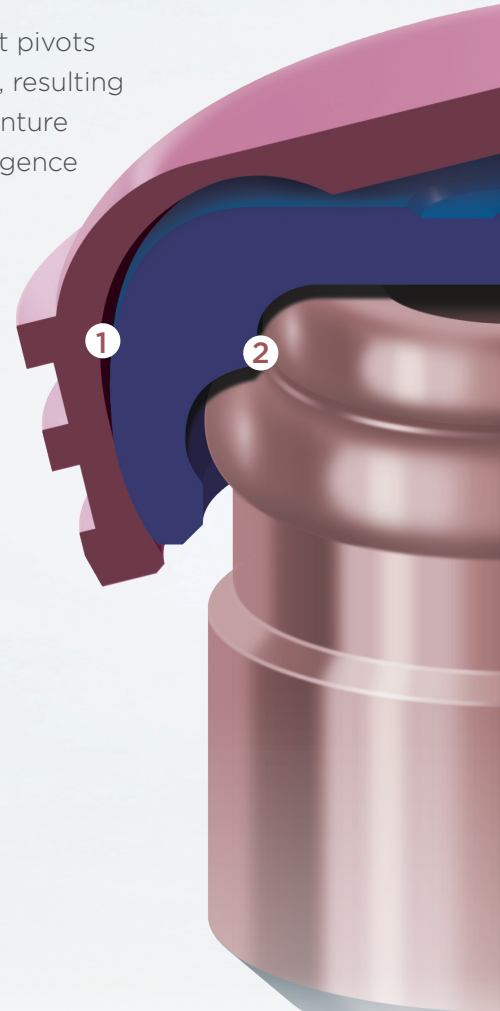
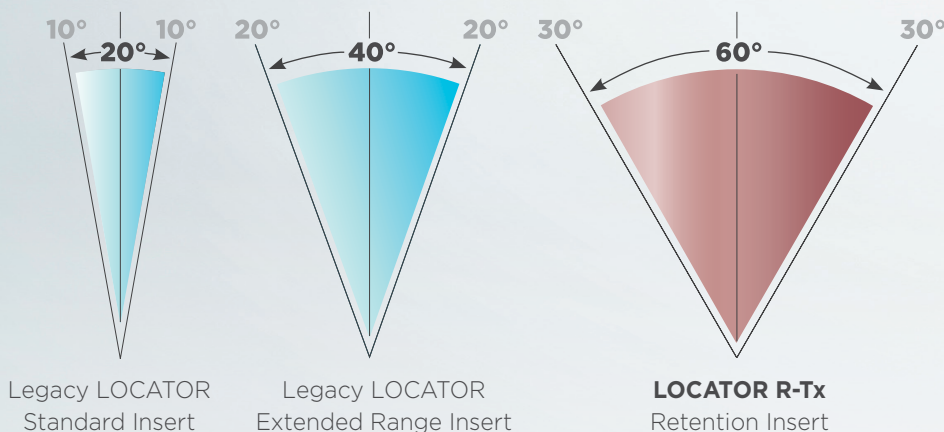

2 NARROWER CORONAL GEOMETRY



The dual engaging geometry of the abutment offers a narrower leading edge and taper-like effect to allow the patient to more easily align and properly seat the overdenture.

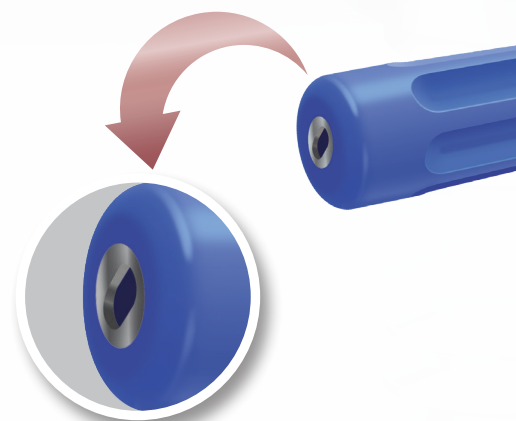
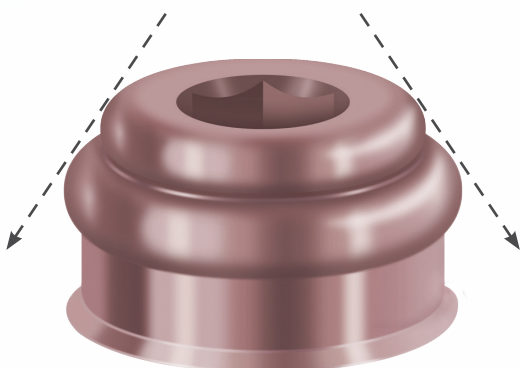

Metal Slot Feature

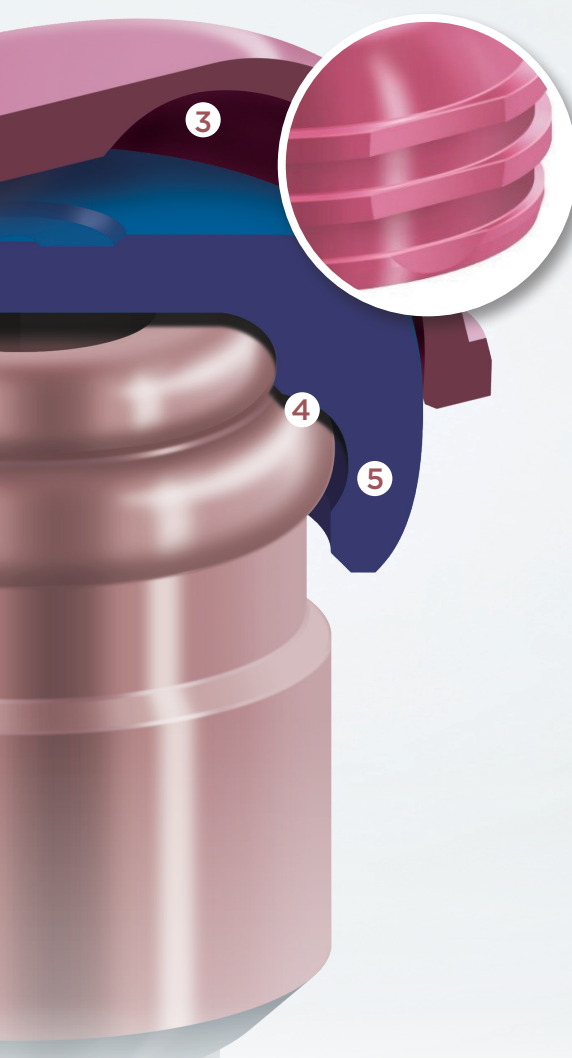

3 PRACTICAL DENTURE ATTACHMENT HOUSING DESIGN



Horizontal grooves and flats resist vertical and rotational movement and a channel inside the top of the Housing enhances pivot range of motion. New pink anodization improves aesthetics in areas of thin denture acrylic.

4 EFFICIENT ABUTMENT/INSERT ENGAGEMENT

The Nylon Retention Inserts now engage dual retentive surfaces on the exterior of the Abutment. No internal engagement prevents debris and plaque accumulation within the drive mechanism from impacting proper seating.

5 NEW RETENTION INSERT DESIGN

Improved design resists edge deformation. Simplicity is also top of mind - the system utilizes only one set of Retention Inserts with straightforward retention values - Zero, Low, Medium, High.



6 CONVENIENT ALL-IN-ONE PACKAGING



Custom designed all-in-one, double-ended vial separately holds Abutment and Processing Components providing all the necessary components for the case with one part number.

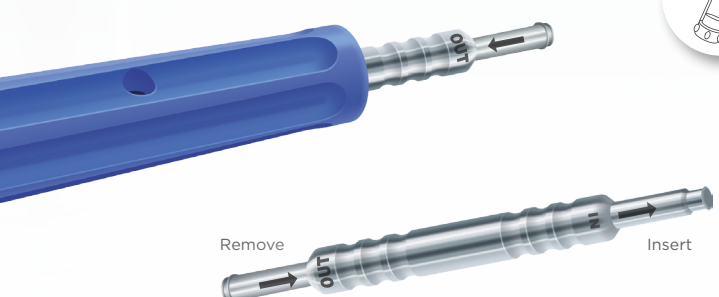

CUSTOM RETENTION INSERT TOOL

Dual-sided tool for easy insertion and removal of the LOCATOR R-Tx Retention Insert. Metal slot feature on the back of the Tool Handle allows the clinician to disengage a Retention Insert without the risk of tearing gloves.

LOCATOR R-Tx™

Abutment Placement

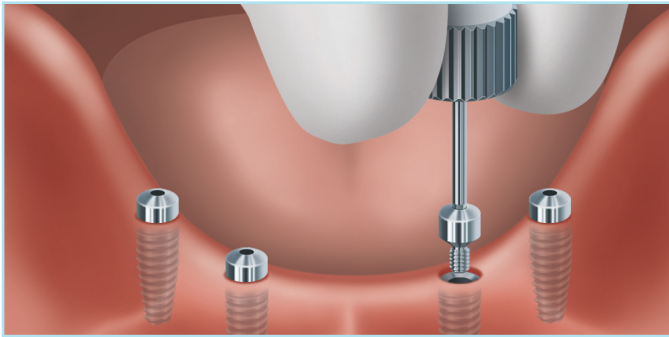

1 Identify the system and diameter of each implant. Remove the healing abutments.

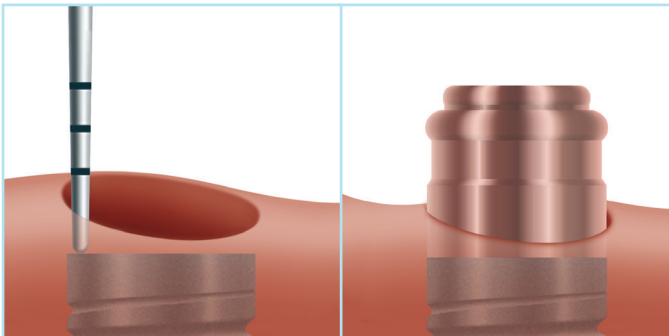

2A-2B Using a periodontal probe, measure the height of the gingiva at the highest point and select the cuff height of the LOCATOR R-Tx Abutment that corresponds to that measurement. If it is 2mm, choose a 2mm cuff height. An additional 2mm of abutment height will extend above the gingiva to accommodate the seated Denture Attachment Housing and Nylon Retention Insert.

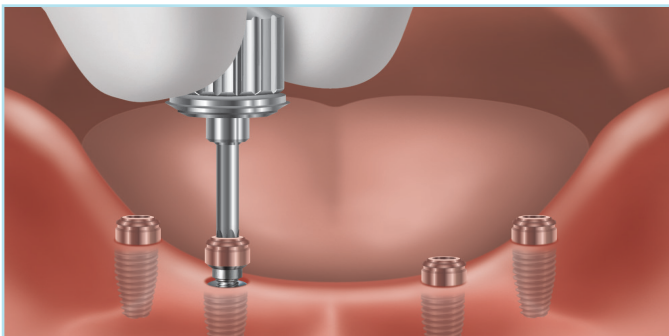

3 Place the LOCATOR R-Tx Abutment into the implant using a .050"/1.25mm* hex driver and hand tighten. Radiograph each interface to confirm that the Abutments are fully seated on the implants by placing the film perpendicular to the interface.

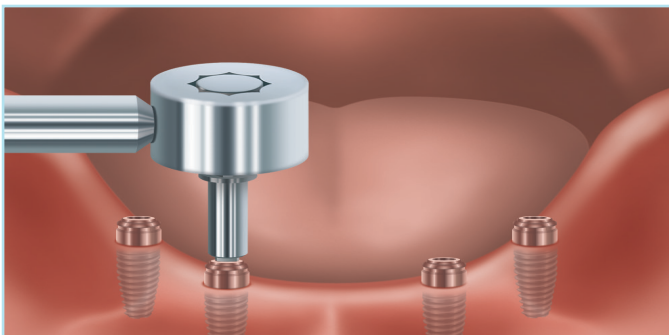

4 Complete the seating of the R-Tx Abutment by using a calibrated torque wrench. Tighten the LOCATOR R-Tx Abutment to 30Ncm.

NOTE: LOCATOR R-Tx Abutments designed for implants with an internal thread diameter of $\leq 1.4\text{mm}$ must be torqued to 20Ncm. The use of higher torque values than recommended could cause a fracture of the LOCATOR R-Tx Abutment.

A direct or indirect technique may be used for processing the Denture Attachment Housings into the denture.

Please refer to page 8 for direct and page 11 for indirect processing techniques for the LOCATOR R-Tx Removable Attachment System.

LOCATOR R-Tx™

Processing Denture Attachment Housings into the Denture - Direct Technique

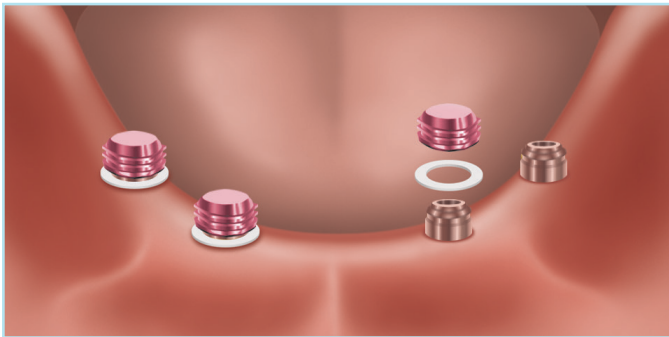

1 Place a White Block-Out Spacer around each Abutment and press it down to the tissue. Snap a Denture Attachment Housing with a pre-loaded Black Processing Insert onto each Abutment, pressing down firmly.

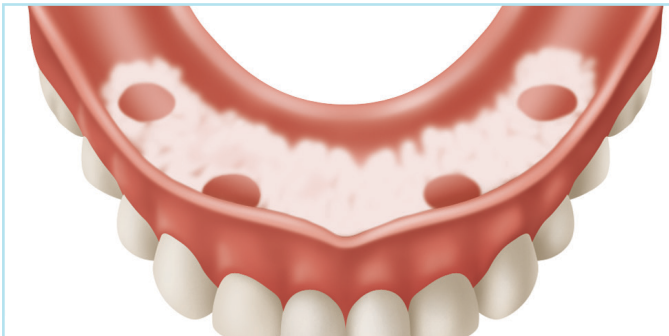

2 Apply fit check marking paste to the intaglio surface of the denture. Insert it into the mouth in position over the Denture Attachment Housings. This will mark areas where the denture will need to be relieved to allow space for the Housings to be picked up.

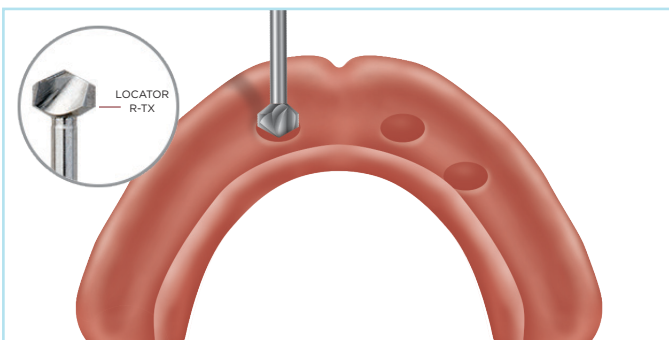

3 Relieve the marked areas with the CHAIRSIDE® Recess Bur. ZEST recommends using slight pressure and a small rocking motion to get the tip of the Bur started, followed by a straight downward motion to create the desired recess site. This Bur has distinct depth landmarks which indicate where to stop when drilling for the Denture Attachment Housing.

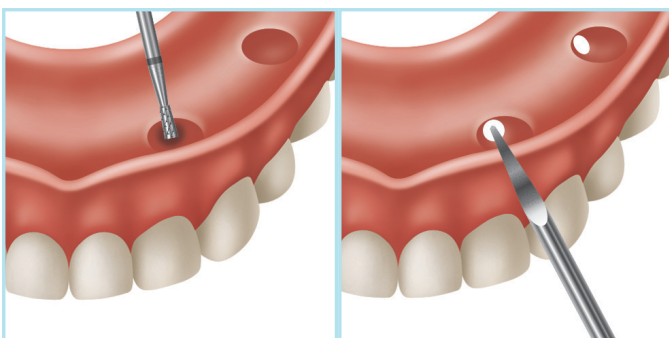

4A-4B Use the CHAIRSIDE Undercut Bur to cut an undercut around the circumference of the relief areas for mechanical retention. Cut lingual/palatal vent windows in the denture with the CHAIRSIDE Vent Bur to visualize full seating and for excess material to vent.

LOCATOR R-Tx™

Processing Denture Attachment Housings into the Denture - Direct Technique (continued)

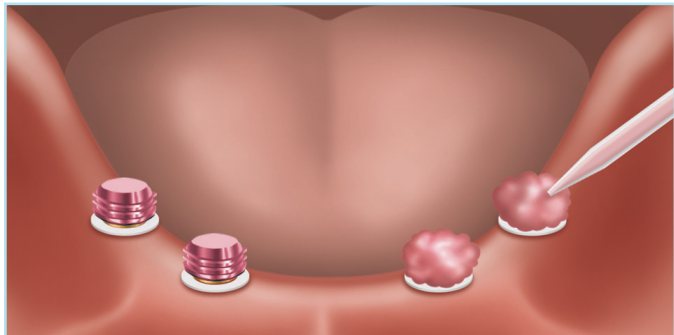

5 Dry the Denture Attachment Housings. Apply a small amount of CHAIRSIDE® Attachment Processing Material around the circumference of each Housing. Place CHAIRSIDE Material into the relief areas of the denture and seat it over the Housings and onto the tissue. Have the patient close into light occlusion and hold while the CHAIRSIDE Material sets. Please refer to CHAIRSIDE Attachment Processing Material IFU for set times.

NOTE: Excessive occlusal pressure during the setting time may cause tissue recoil against the denture base and could contribute to dislodging and premature wear of the Inserts.

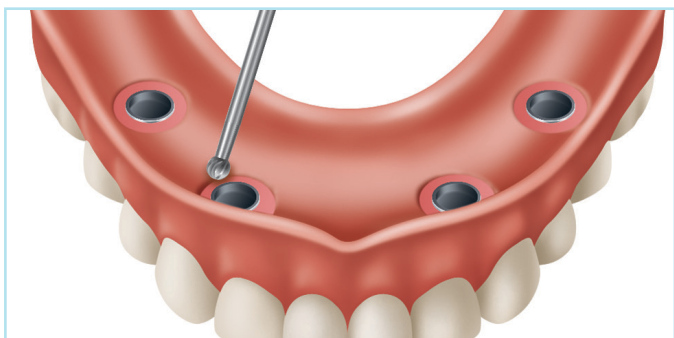

6 Disengage the denture from the Abutments and remove from the mouth. Verify that the Denture Attachment Housings have been securely processed into the denture. Fill any voids with CHAIRSIDE Material and light cure. The material will bond to itself and will cure within 30 seconds with light application. Remove any excess material with the CHAIRSIDE Grind Bur.

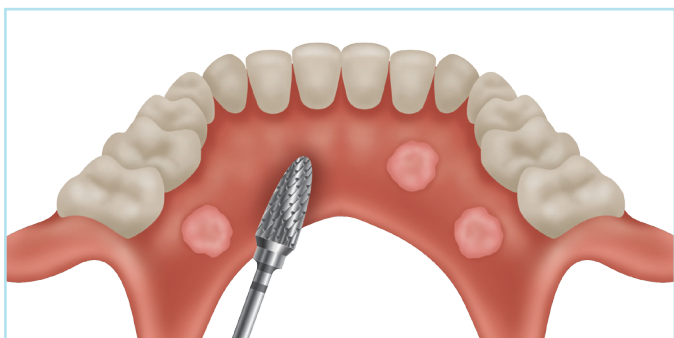

7 Use the CHAIRSIDE Trim Bur to remove any excess acrylic material remaining on the denture and to make any needed modifications to the denture.

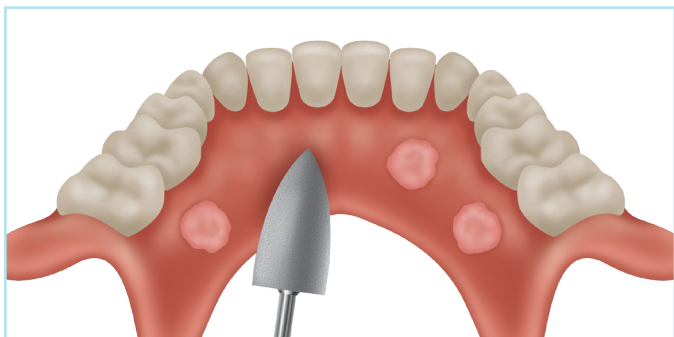

8 Use the CHAIRSIDE Polish Bur to create a smooth finish of the denture.

LOCATOR R-Tx™

Processing Denture Attachment Housings into the Denture - Direct Technique (continued)

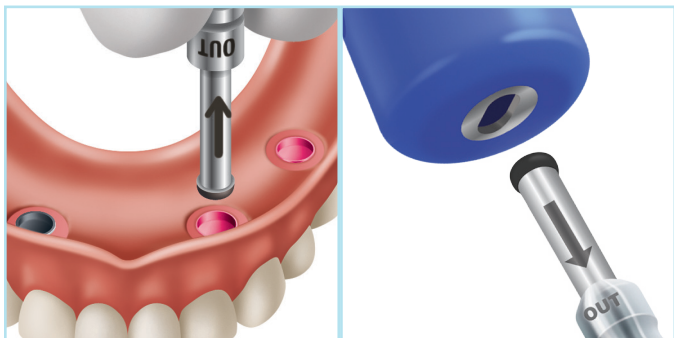

9A-9B Remove the Black Processing Insert from the Denture Attachment Housing using the removal (OUT) end of the Retention Insert Tool. When using the removal end of the Tool, engage the Processing Insert and tip the Tool towards the distal or mesial of the intaglio surface until the Insert completely disengages from the Denture Attachment Housing.

Use the metal slot feature on the back end of the Tool to remove the Insert from the tip of the Tool. This can be accomplished by sliding the Insert into the opening of the metal slot and using an upward motion to remove the Insert.

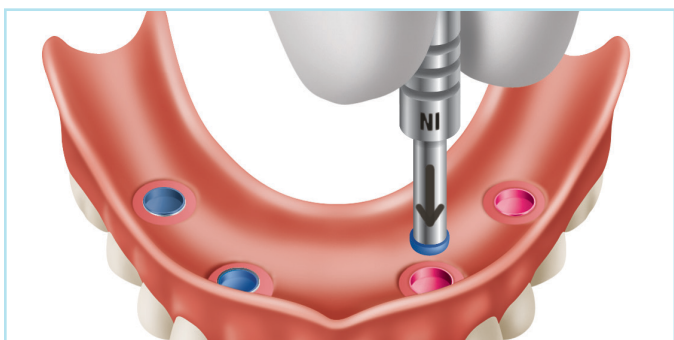

10 Place the selected final Retention Insert into each Denture Attachment Housing using the insertion (IN) end of the Tool. During try-in, start with the lowest retentive option. When using the insertion end of the Tool, engage the Retention Insert from a slight angle and upright the Tool while pressing down.

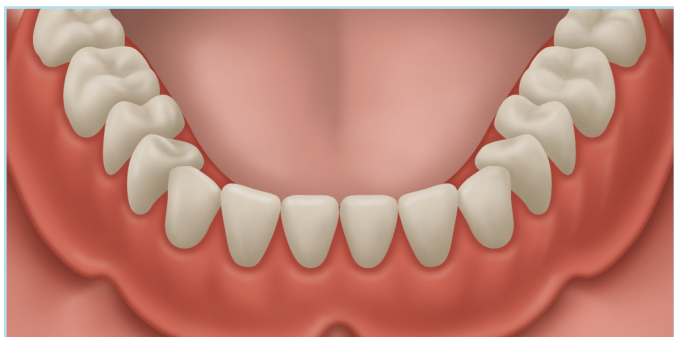

11 Seat the denture, press down to engage the Inserts on the LOCATOR R-Tx Abutments and verify the occlusion. Instruct the patient on how to remove and insert the denture. If the retention is not satisfactory, remove the Inserts and replace with the next level of retention. Please refer to the Retention Inserts section of the Components Reference on page 2 for available levels of retention. Instruct the patient on proper home care maintenance and required recall visits.

LOCATOR R-Tx™

Processing Denture Attachment Housings into the Denture - Indirect Technique



1 INDIRECT TECHNIQUE/LABORATORY PROCESSING

A stock or custom impression tray may be used. Ensure that each recess has enough space for the height and diameter of the LOCATOR R-Tx Impression Copings.

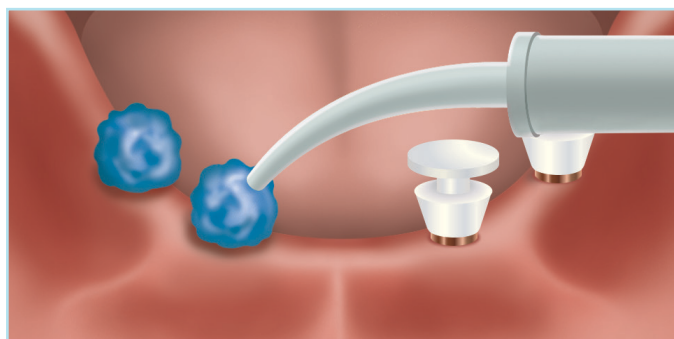

2 Place a LOCATOR R-Tx Impression Coping on each Abutment and press down firmly. Syringe a medium body impression material around the circumference of each coping. Fill the impression tray and insert it over the copings and onto the tissue. Allow the material to set and remove the impression tray.

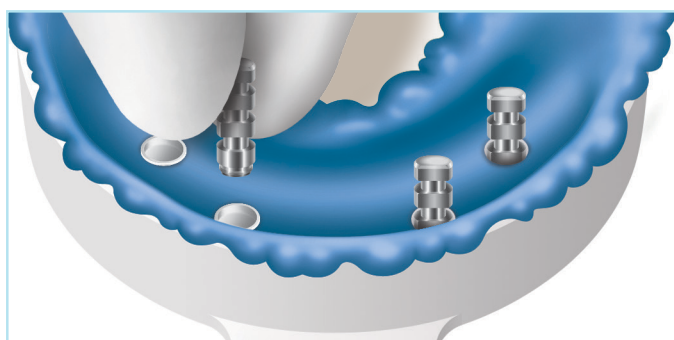

3 Seat the appropriate diameter LOCATOR R-Tx Analog into each Impression Coping and send the impression to the laboratory.

LOCATOR R-Tx™

Processing Attachment Housings into the Denture - Indirect Technique (continued)

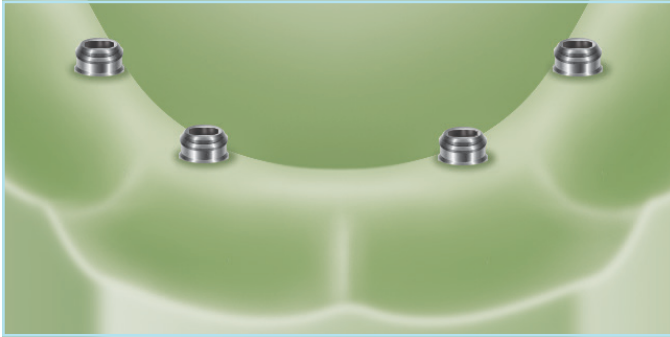

4 Verify that the Analogs are secure in the Impression Copings and pour a model.

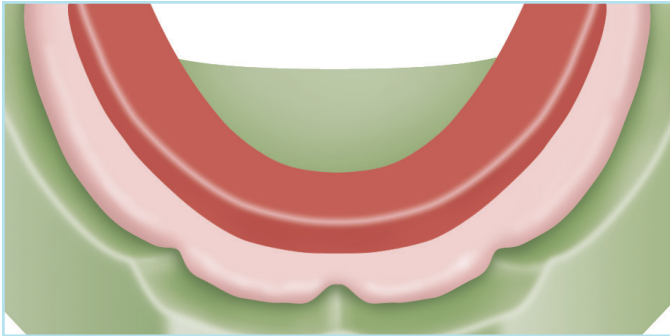

5 Fabricate the baseplate and wax rim on the cast for the bite registration. The Denture Attachment Housings with Black Processing Inserts may be processed into the baseplate to provide stabilization during record making and try-in.

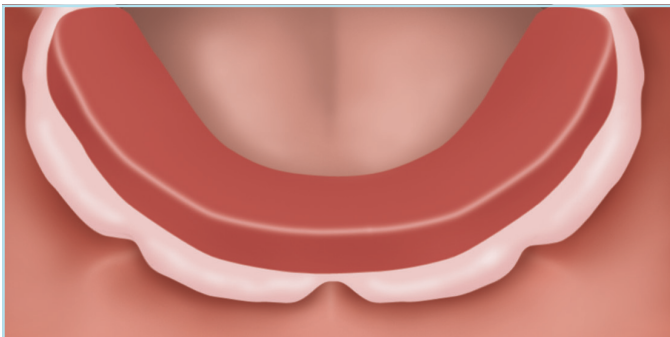

6 BITE RECORDS

Place the bite block into the mouth and record the jaw relation. Take an impression of the opposing arch and pour the cast. Select a shade for the denture teeth.

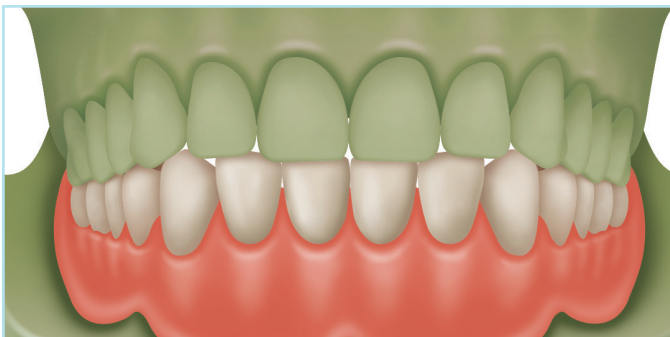

7 Articulate the models and proceed with the denture teeth set up.

LOCATOR R-Tx™

Processing Attachment Housings into the Denture - Indirect Technique (continued)

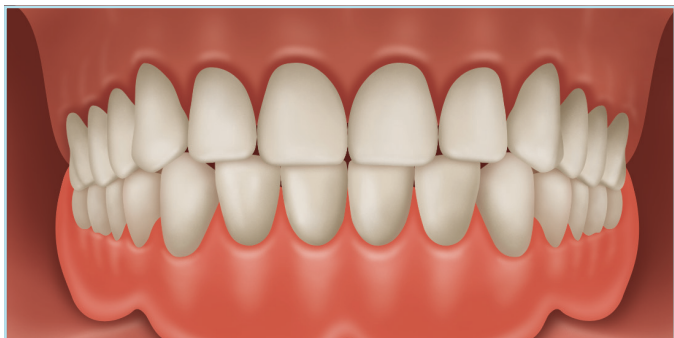

8 DENTURE TRY-IN

Place the try-in denture into the mouth and verify the fit, attachment engagement, aesthetics, phonetics and occlusion.

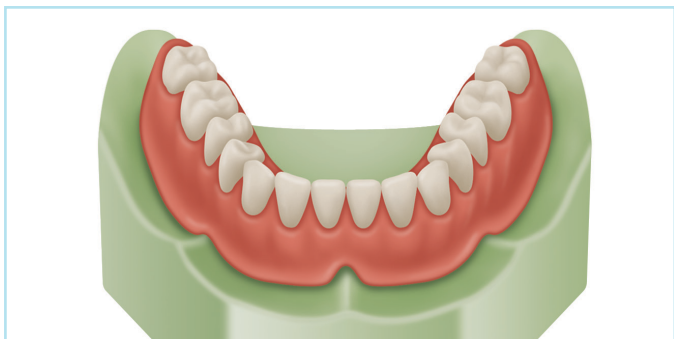

9 Finalize and flask the denture for processing. Separate the flask and boil away all wax. Place the Denture Attachment Housings with Black Processing Inserts on the Analogs and press down firmly. Place the cast back into the flask and verify that there is no contact with the teeth. Close the flask and process the denture. Remove the denture from the flask, finish, and polish.

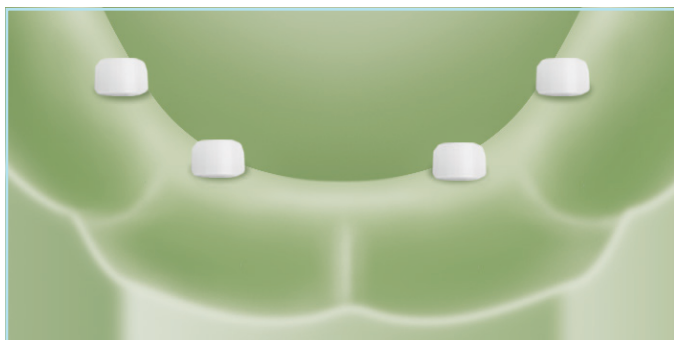

10 **Optional Step:** A Processing Spacer could be used instead of the Denture Attachment Housing during the fabrication of the denture if the clinician prefers to pick up the Denture Attachment Housings chairside. The Processing Spacer creates a recess in the denture to allow for the Denture Attachment Housing to be seated without any interference with the surrounding denture acrylic.

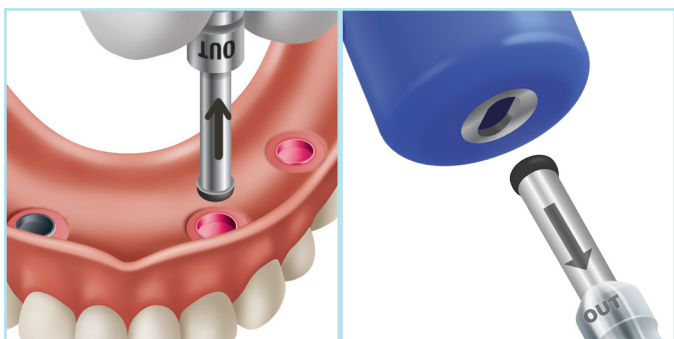

11A-11B Remove the Black Processing Insert from the Denture Attachment Housing using the removal (OUT) end of the Retention Insert Tool. When using the removal end of the Tool, engage the Processing Insert and tip the Tool towards the distal or mesial of the intaglio surface until the Insert completely disengages from the Denture Attachment Housing.

Use the metal slot feature on the back end of the Tool to remove the Insert from the tip of the Tool. This can be accomplished by sliding the Insert into the opening of the metal slot and using an upward motion to remove the Insert.

LOCATOR R-Tx™

Processing Attachment Housings into the Denture - Indirect Technique (continued)

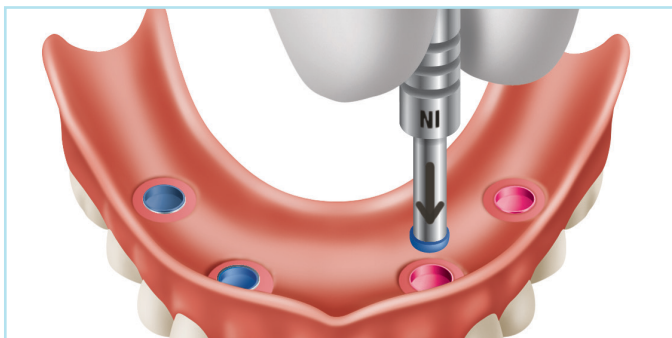

12 Place the selected final Retention Insert into each Denture Attachment Housing using the insertion (IN) end of the Tool. During try-in, start with the lowest retentive option. When using the insertion end of the Tool, engage the Retention Insert from a slight angle and upright the Tool while pressing down.

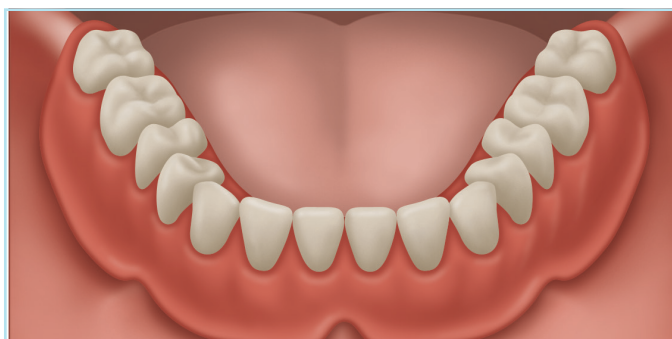

13 DELIVERY

Place the denture in the mouth and press down to engage the Retention Inserts on the R-Tx Abutments. Verify the occlusion. Instruct the patient on how to remove and insert the denture. If the retention is not satisfactory, remove the Retention Inserts and replace with the next level of retention. Please refer to the Retention Inserts section of the Components Reference on page 2 for available levels of retention. Instruct the patient on proper home care maintenance and required recall visits.

MAINTENANCE OF THE LOCATOR R-Tx™ ABUTMENT

Reline of Implant-Retained Tissue Supported Overdentures

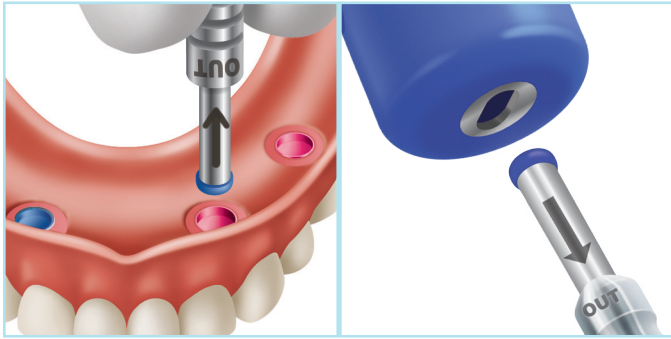

1A-1B Remove the Retention Inserts from the denture using the removal (OUT) end of the Retention Insert Tool. When using the removal end of the Tool, engage the Retention Inserts and tip the Tool towards the distal or mesial of the intaglio surface until the insert completely disengages from the Denture Attachment Housing.

Use the metal slot feature on the back end of the Tool to remove the Insert from the tip of the Tool. This can be accomplished by sliding the Insert into the opening of the metal slot and using an upward motion to remove the Insert.

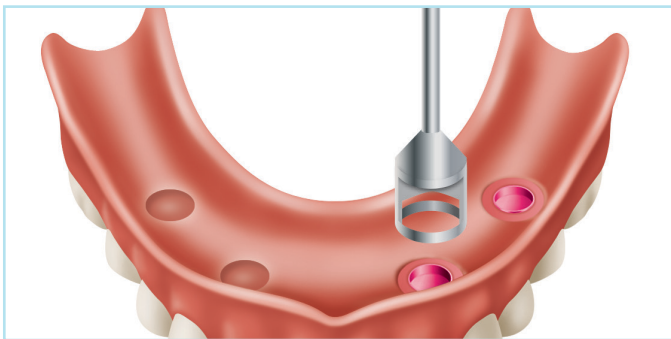

2 Using a trephine drill, remove the existing Denture Attachment Housings from the overdenture.

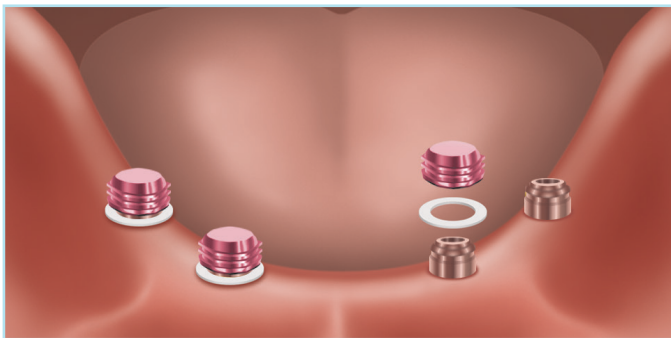

3 Place a white Block-Out Spacer around each Abutment and press it down to the tissue. Snap a new Denture Attachment Housing with a pre-loaded Black Processing Insert onto each Abutment, pressing down firmly. Try in the overdenture to ensure each recess is large enough to accommodate the new Denture Attachment Housing with no interference with the acrylic.

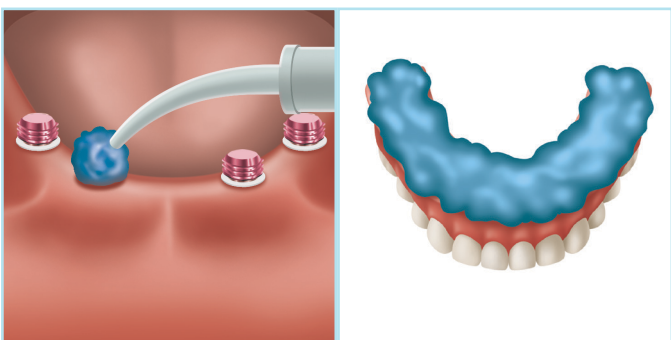

4A-4B Apply impression adhesive to the intaglio surface of the overdenture and apply a medium body impression material. Take an impression and have the patient close into light centric occlusion. Remove the overdenture and verify that all the Denture Attachment Housings are picked up in the impression.

MAINTENANCE OF THE LOCATOR R-Tx™ ABUTMENT

Reline of Implant-Retained Tissue Supported Overdentures

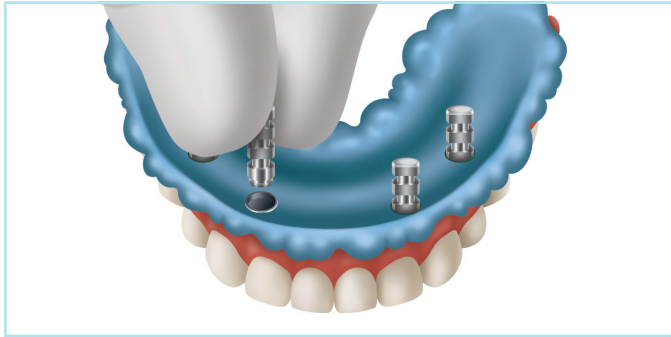

5 Seat the appropriate diameter LOCATOR R-Tx Analog into each Denture Attachment Housing and pour a model.



6 Verify that the Analogs are secure in the Black Processing Inserts and pour a master cast.



7 Mount the cast with the denture in a reline jig.

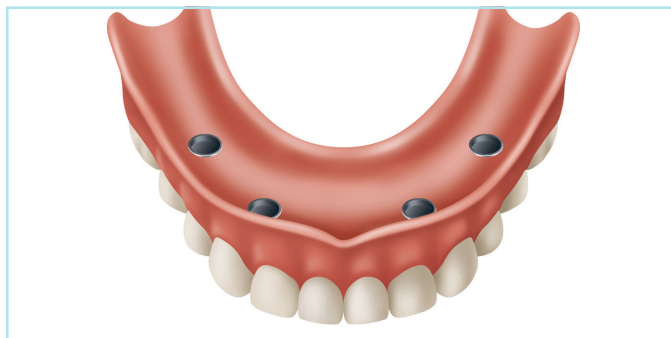

8 Separate the reline jig and remove the impression material from the overdenture. Seat the overdenture and the Denture Attachment Housings back on the Analogs and reline.

Remove the overdenture from the reline jig, finish and polish.

MAINTENANCE OF THE LOCATOR R-Tx™ ABUTMENT

Reline of Implant-Retained Tissue Supported Overdentures (Continued)

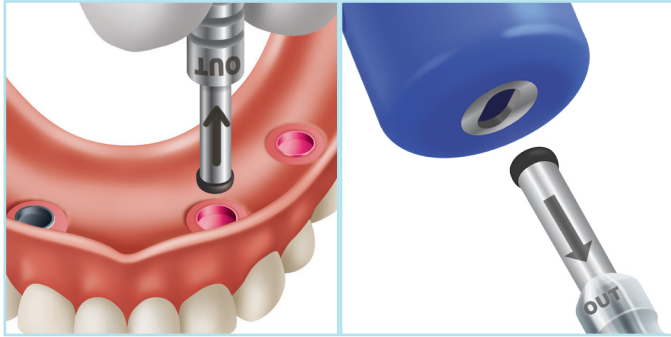

9A-9B Remove the Black Processing Inserts from the denture using the removal (OUT) end of the Retention Insert Tool. When using the removal end of the Tool, engage the Processing Inserts and tip the Tool towards the distal or mesial of the intaglio surface until the Insert completely disengages from the Denture Attachment Housing.

Use the metal slot feature on the back end of the Tool to remove the Insert from the tip of the Tool. This can be accomplished by sliding the Insert into the opening of the metal slot and using an upward motion to remove the Insert.

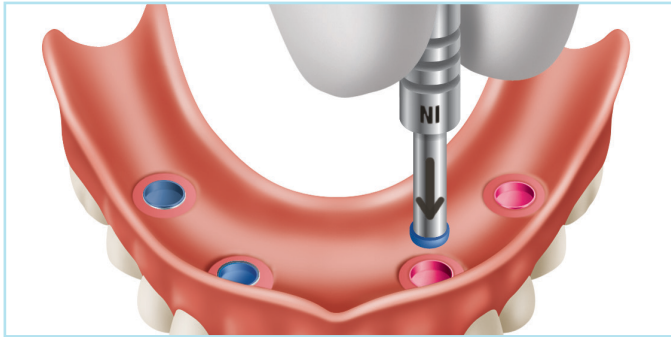

10 Place the selected final Retention Insert into each Denture Attachment Housing using the insertion (IN) end of the Tool. During try-in, start with the lowest retentive option. When using the insertion end of the Tool, engage the Retention Insert from a slight angle and upright the Tool while pressing down.

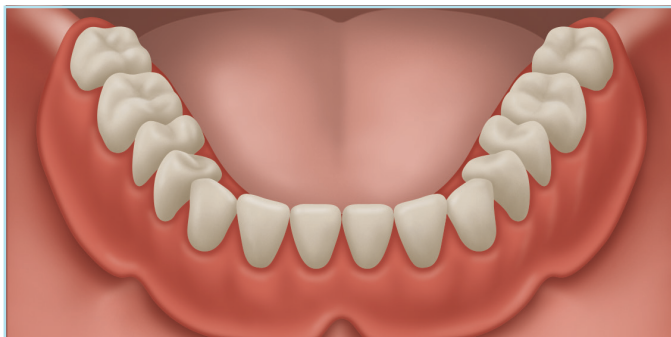

11 DELIVERY

Place the denture in the mouth and press down to engage the Retention Inserts on the Abutments. Verify the occlusion. If the retention is not satisfactory, remove the Retention Inserts and replace with the next level of retention. Please refer to the Retention Insert section of the Components Reference on page 2 for available levels of retention. Instruct the patient on proper home care maintenance and required recall visits.

IMPORTANT INFORMATION ABOUT THE LOCATOR R-Tx™ REMOVABLE ATTACHMENT SYSTEM

INDICATIONS

The LOCATOR® R-Tx Attachment System is designed for use with overdentures or partial dentures, retained in whole or in part, by endosseous implants in the mandible or maxilla.

CONTRAINDICATIONS

Not appropriate where a totally rigid connection is required. Use of a single implant with divergence of greater than 30 degrees from vertical is not recommended. Not appropriate to be used for a fixed restoration.

CAUTION

Federal (USA) law restricts this device to the sale by or on the order of a licensed dentist.

SINGLE-USE DEVICES

The LOCATOR R-Tx Attachment System components, with the exception of the Retention Insert Tool, are single-use devices.

Single-Use Devices must not be reused or re-sterilized.

LOCATOR R-TX RETENTION INSERT TOOL

Dual-sided tool for easy insertion and removal of the LOCATOR R-Tx Retention Insert. Metal slot feature on the back of the Tool allows the clinician to disengage a Retention Insert.

The Tool is designed for multiple uses. If the Tool becomes worn or damaged, obtain a replacement Tool.

When using the removal end (OUT) of the Tool, engage the Processing Insert and tip the Tool towards the distal or mesial of the intaglio surface until the Insert completely disengages from the Denture Attachment Housing.

Use the metal slot feature on the back end of the Tool to remove the Insert from the tip of the Tool. This can be accomplished by sliding the Insert into the opening of the metal slot and using an upward motion to remove the Insert.

When using the insertion (IN) end of the Tool, engage the Retention Insert from a slight angle and upright the Insert Tool while pressing down.

CLEANING

- Disassemble the instruments (i.e. Retention Insert Tool)

- Soak the instruments in enzymatic cleaning solution (mixed according to manufacturer's instructions) by completely submerging them for 20 minutes. Scrub the components using a soft-bristled, nylon brush until all soil has been removed.

- Remove the instruments from the enzymatic cleaning solution and rinse in tap water for a minimum of 3 minutes. Make sure to thoroughly flush internal holes/crevices of the instruments that have difficult to reach areas.

- If additional cleaning is needed, place instruments in an ultrasonic cleaner (with enzymatic cleaning solution prepared according to manufacturer's instructions) making sure that they are completely submerged, and sonicate for 10 minutes.

- Remove the instruments from the ultrasonic cleaner and rinse for 3 minutes making sure to thoroughly flush cleaning solution out of the holes/crevices and/or difficult to reach areas.

- Remove excess moisture from the instruments with a clean, absorbent, non-shedding wipe.

STERILIZATION

Wrap the components using a wrap that is FDA-cleared for the indicated cycles. All components and instruments are supplied NON-STERILE. Titanium abutments and instruments may be sterilized by Autoclave sterilization using the following parameters:

| | Gravity Autoclave | Pre-Vacuum Autoclave |
|---------------|-------------------|----------------------|
| Temperature | 132°C | 132°C |
| Exposure Time | 15 minutes | 4 minutes |
| Dry Time | 30 minutes | 20 minutes |

In order to ensure that the Inserts are sterilized/disinfected (all microorganisms including Clostridium sporogenes and Bacillus subtilis spores are eliminated), the Inserts must be soaked for a minimum of 3 hours in a liquid sterilant at room temperature.

NOTE: An FDA approved liquid chemical sterilant for critical devices that are heat-sensitive and incompatible with sterilization methods such as steam and gas/vapor/plasma low temperature processes may be used following the manufacturer's directions for the sterilization of the device.

OVERDENTURE INSERTION, REMOVAL, AND CLEANING GUIDELINES For The Clinician And Patient

To reduce wear on LOCATOR R-Tx™ Abutments, it is critical that clinicians and patients perform routine maintenance on both the LOCATOR R-Tx Abutment, the Denture Attachment Housing and the Retention Insert. It is also important that patients understand the proper overdenture maintenance that should be performed at home to guard against retention loss of the Retention Insert within the Denture Attachment Housing. The following are guidelines to consider:

INSERTING AND REMOVING AN OVERDENTURE

To insert the overdenture, the patient should ensure he/she can feel that it is properly positioned above the LOCATOR R-Tx Abutments prior to applying pressure. The patient should use both hands and simultaneously press down on each side to firmly seat the overdenture into place.

The patient should avoid biting the overdenture into place as this force will result in improper wear of the LOCATOR R-Tx Abutment and may affect the longevity of the prosthesis.

The patient should remove the overdenture by placing one finger under the left edge and one under the right edge of the overdenture and pull one side upward at a time. Once the overdenture is removed a thorough cleaning is recommended.

CLEANING AN OVERDENTURE

Maintaining proper hygiene is vital to the success of an overdenture, helping it last longer and function properly. Similar to natural teeth, dental plaque will also form on the surface of an overdenture. If the plaque is not removed it will continue to accumulate. It is for this reason that the overdenture should be taken out for cleaning daily. Patients should follow these two simple steps daily for cleaning an overdenture.

1 Fill a washing basin with warm water to prevent fracture of the overdenture. Apply detergent onto a soft bristle toothbrush and thoroughly clean every surface of the overdenture.

2 Before bed each night, remove the overdenture and immerse in a cup of plain cold water.

ADDITIONAL NOTES OF CAUTION

Failure of the patient to follow oral hygiene protocols and appropriately care for the overdenture may also result in inflamed tissue around the implant, leading to the development of peri-implantitis. Throughout time, peri-implantitis may cause the implant to become mobile and fail. Please ask patients to consider the following when caring for their overdentures:

- Avoid using abrasive toothpaste to clean the overdenture. The coarse particles in the toothpaste may scratch the surfaces of the overdenture, enhancing the potential for plaque accumulation.
- Chewing tobacco may get caught in the Retention Inserts and scratch the Abutments, considerably reducing the life of the Abutments, retentive features of the Retention Inserts and ultimately may affect the dental implants.
- Do not soak the overdenture in bleach or any other products not designed for use with denture cleaning as these can harm the retentive feature of the Retention Insert, which may ultimately cause additional wear on the Abutment.
- If a denture cleaning solution such as Polident® and Efferdent® must be used, it is recommended that the denture be soaked for fifteen minutes or less.
- Brushing the Abutments increases wear; if the patient brushes their Abutments, he/she should use a soft-bristled brush and visit the dentist for regular inspection and maintenance of the Abutments, Retention Inserts and Attachment Housings.
- Refrain from picking at the Abutments with toothpicks or other foreign objects.
- Refrain from eating without the overdenture in place as food will scratch the Abutment and may result in failure of the dental implant.
- Oral rinse such as Listerine® mouthwash can be used safely without any negative effect on the Abutments or Retention Inserts.
- Do not wash the overdenture in the dishwasher.

RETURN POLICY AND WARRANTY

ORDERING

Orders are accepted by internet, email, mail, fax, or phone. Regular business hours are 7:00am to 5:00pm PST (Pacific Standard Time). Domestic orders received by 1:00pm PST can be shipped by ground the same day. Orders received by 3:00pm PST can be shipped by express. Institutional orders require a purchase order number.

PRICING

ZEST Anchors LLC makes every effort to maintain a competitive pricing structure. Pricing is subject to routine review and change without prior notice. All prices listed are in U.S. dollars.

TERMS AND BILLING

- A. **Credit Card:** Payment at the time of order with VISA, AMERICAN EXPRESS, DISCOVER or MASTERCARD is necessary for customers not approved for open account billing or special financing offers.
- B. **C.O.D.:** Delivery can also be made by C.O.D. freight collect.
- C. **Open Account:** An open account can be established by completing a credit application and receiving approval by ZEST Anchors LLC. The terms of orders purchased under open accounts are net 30 days.
- D. **Export Orders:** Individual orders shipped outside the U.S. require payment in advance or a letter of credit.
- E. **Past Due Accounts:** Past due balances will be subject to a 1.5% finance charge per month, amount equal to 18% per annum.

SHIPPING CHARGES

Merchandise is shipped prepaid by ZEST Anchors LLC with the cost added to the invoice, or freight collect with C.O.D. fee included in the case of C.O.D. shipments. Delivery options include Fed Ex ground, 3-day, 2-day, or overnight rush service.

LIMITED WARRANTY

ZEST Anchors LLC provides a limited warranty for its products, to the original purchaser, to be free from

defects in workmanship and materials under normal use and service, for a period of one year from the date of purchase. ZEST Anchors LLC will, at its option, substitute the returned product that proves defective within the warranty period, with a similar product, free of charge.

ZEST Anchors LLC continually strives to improve its products, and therefore, reserves the right to improve, modify, or discontinue products at any time without notice or incurring obligations. Purchaser assumes all risks and liability resulting from the use of ZEST Products, whether used separately or in combination with other products not of ZEST Anchors LLC manufacture.

RETURN POLICY

Please Observe the Following Guidelines:

- A. Authorization for returns must be received from ZEST Anchors LLC prior to the return of any product. A Return Material Authorization (RMA) number will be provided for all returns.
- B. Shipping charges must be prepaid by the customer to accept a return shipment.
- C. Returned products are subject to a \$20 restocking fee for orders under \$400. For orders \$400 to \$1,000, a \$40 restocking fee will be applied. For orders exceeding \$1,000, please contact your Customer Service Representative for the restocking fee.
- D. Returned merchandise will be accepted within 90 days of purchase if product is in saleable condition (in its original unopened package and not marred by any added writing or over-labeling).
- E. Returns will not be accepted after 90 days of purchase.
- F. Non-returnable items include:
 - 1. Merchandise retained beyond expiration date noted on the package.
 - 2. Packages with broken seals or missing parts
 - 3. Used, damaged, or obsolete products will not be accepted for return.

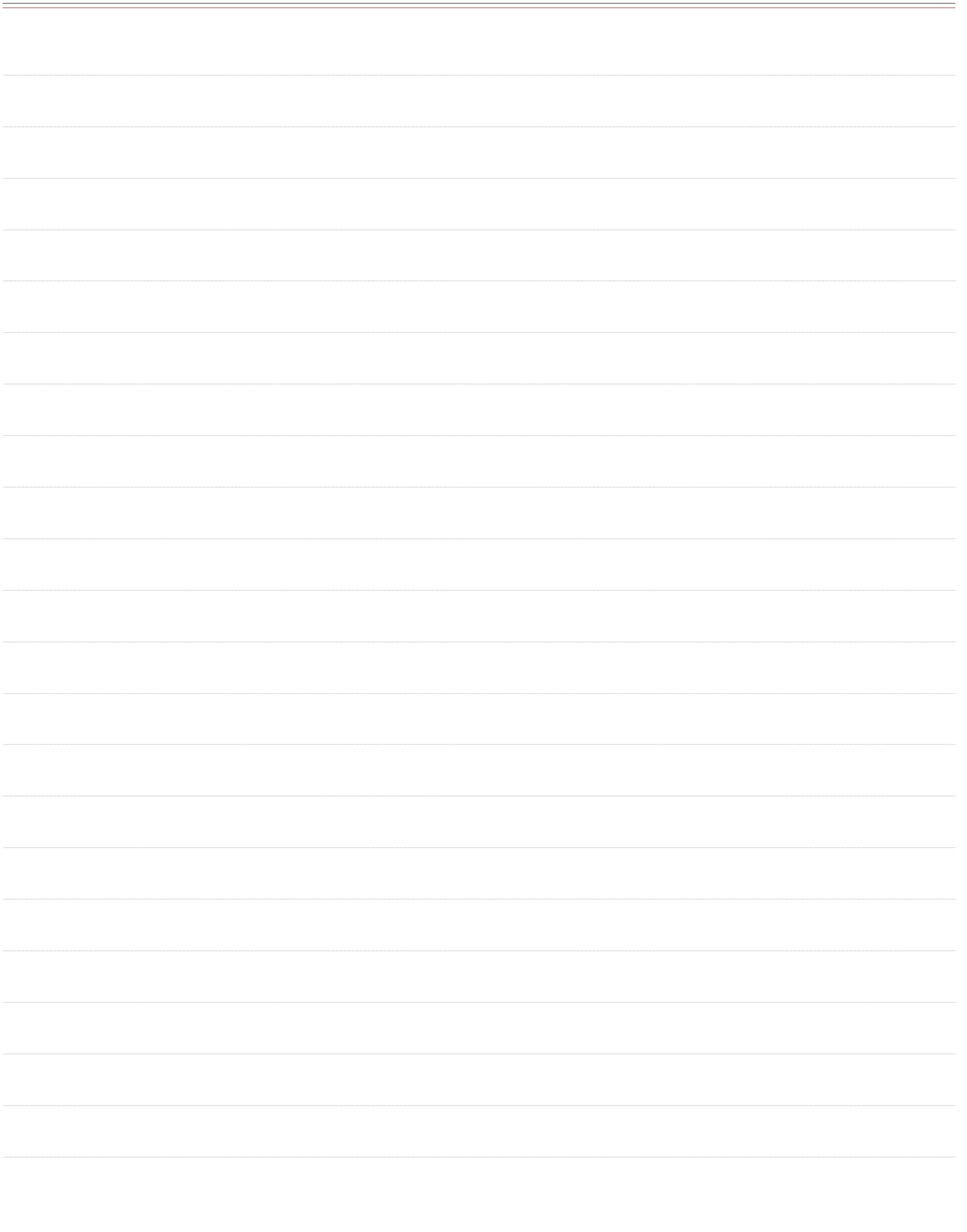

VISIT
ZESTANCHORS.COM
24 HOURS A DAY, 7 DAYS A WEEK,
TO PLACE ORDERS ONLINE OR TO FIND THE
LATEST SUPPORT TOOLS FOR LOCATOR R-Tx™



ZEST ANCHORS
2061 WINERIDGE PLACE
ESCONDIDO, CA 92029
USA

TEL: 800.262.2310
FAX: 760.743.7975
EMAIL: SALES@ZESTANCHORS.COM
WWW.ZESTANCHORS.COM

DISTRIBUTED BY:



Wellkang Ltd
29 Harley St.
W1G 9QR
London U.K.



*Excluding connections that utilize .048" hex drive mechanism. Please contact your implant company provider for more information.

©2016 ZEST Anchors LLC. All rights reserved. CHAIRSIDE, Color and Shape of Retention Inserts, LOCATOR and ZEST are registered trademarks and LOCATOR R-Tx and R-Tx are trademarks of ZEST IP Holdings, LLC. Polident is a registered trademark of Block Drug Company, Inc. Listerine is a registered trademark of Johnson and Johnson. Efferdent is a registered trademark of Blacksmith Brands, Inc.

L8024-TM REVA 01/16